

1. OVERVIEW

The following picture shows the assignment of the individual connection areas on the bottom of the inverter.

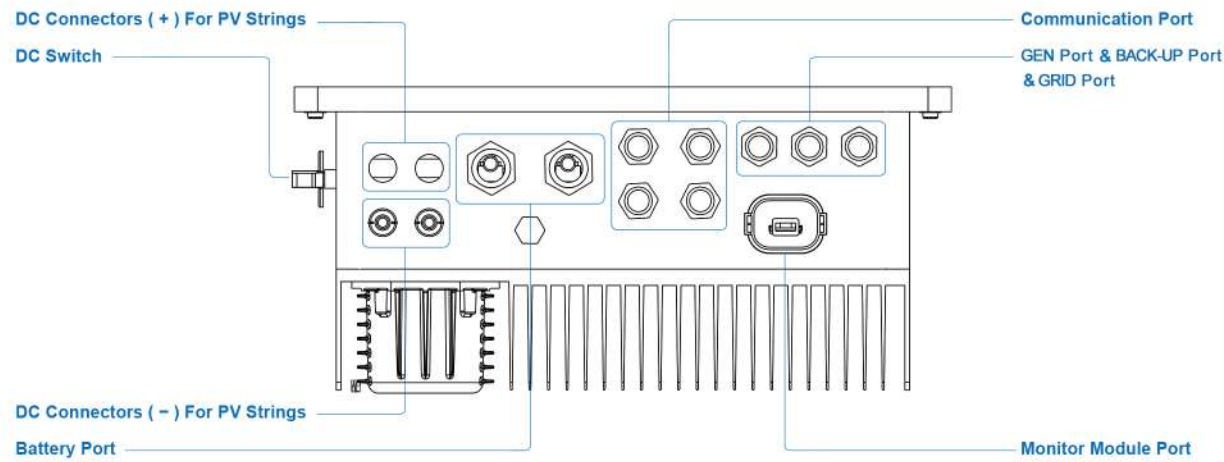

2. PACKAGE LIST

On receiving the inverter, please check to make sure the packing and all components are not missing or damaged. Please contact your dealer directly for supports if there is any damage or missing components.

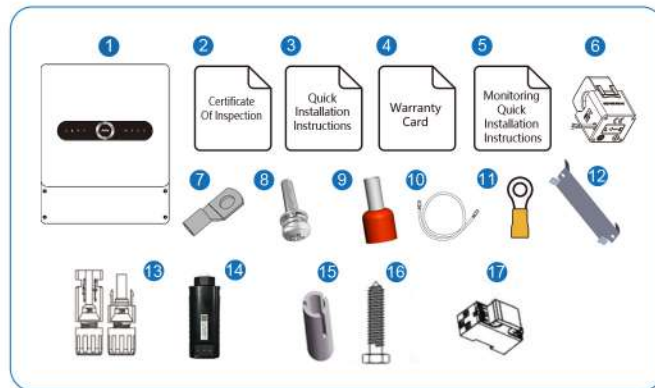

No.	Qty	Items	No.	Qty	Items
1	1	Hybrid Inverter	11	1	Grounding Terminal
2	1	Certificate Of Inspection	12	1	Wall Mounting Bracket
3	1	Quick Installation Instructions	13	1/2	DC Connector
4	1	Warranty Card	14	1	Monitor Module
5	1	Monitoring Quick Installation Instructions	15	2	Expansion Tube
6	1	CT	16	2	Mounting Bracket Screw
7	1	Battery Connector	17	1	Smart Meter (Optional)
8	2	Security Screw			
9	4	AC Wiring Terminal			
10	1	Net cable			

3. QUICK INSTALLATION

A Mounting

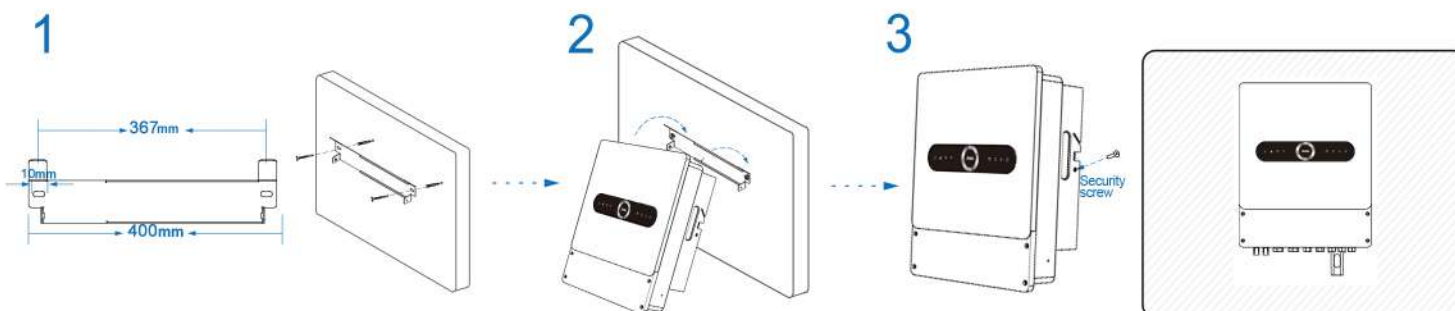

B PV Connection

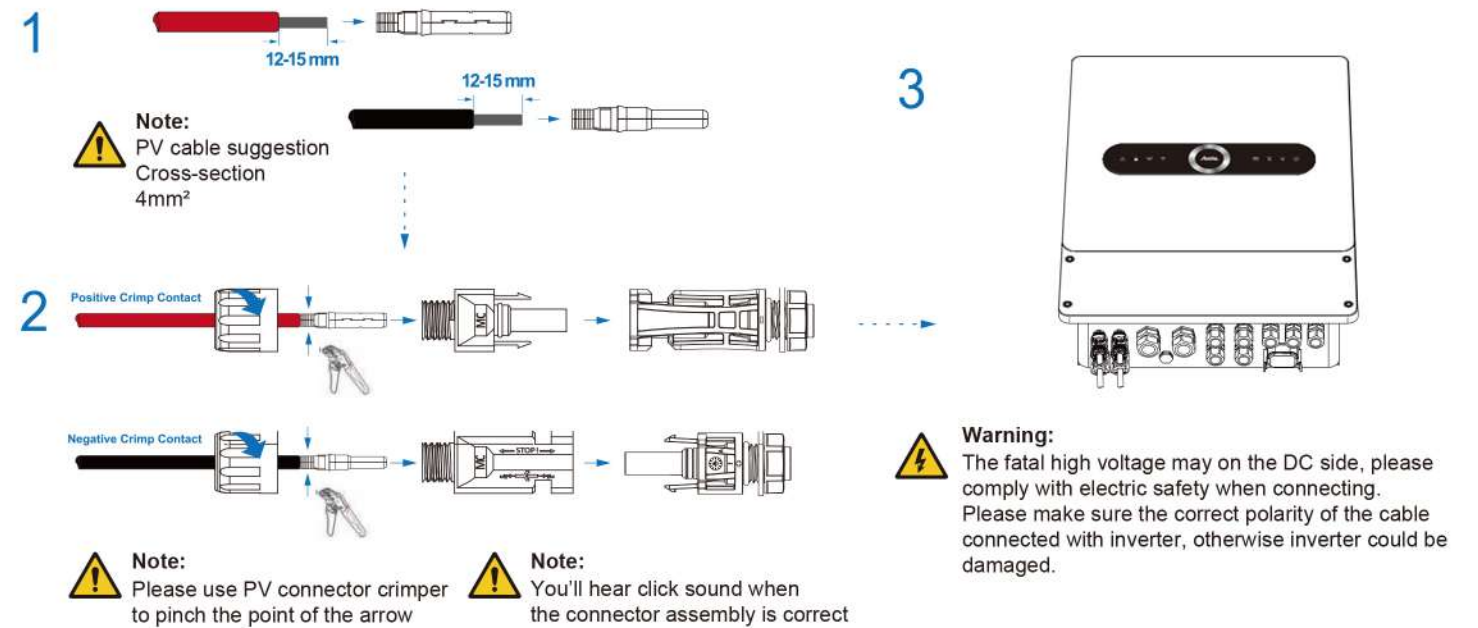

C Battery Connection

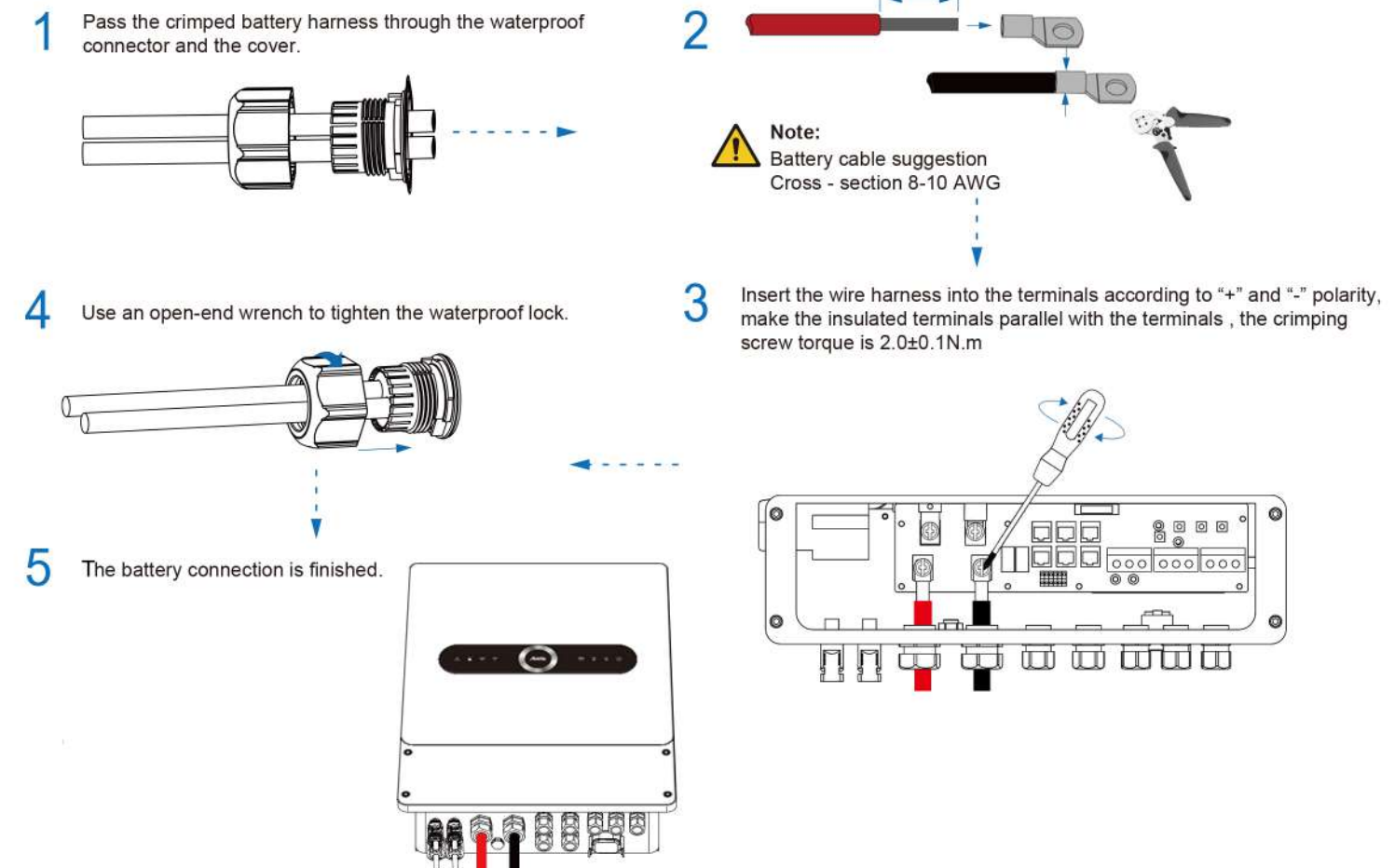

C

Battery Connection

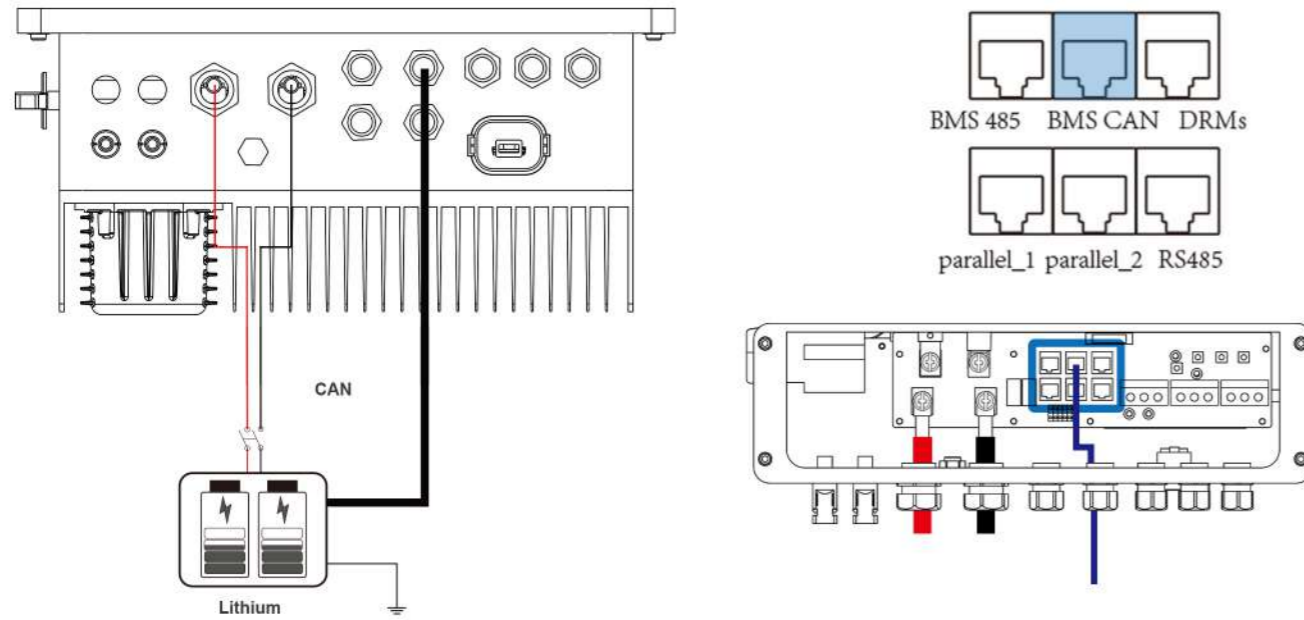

D

GEN, BACK-UP and GRID Connection

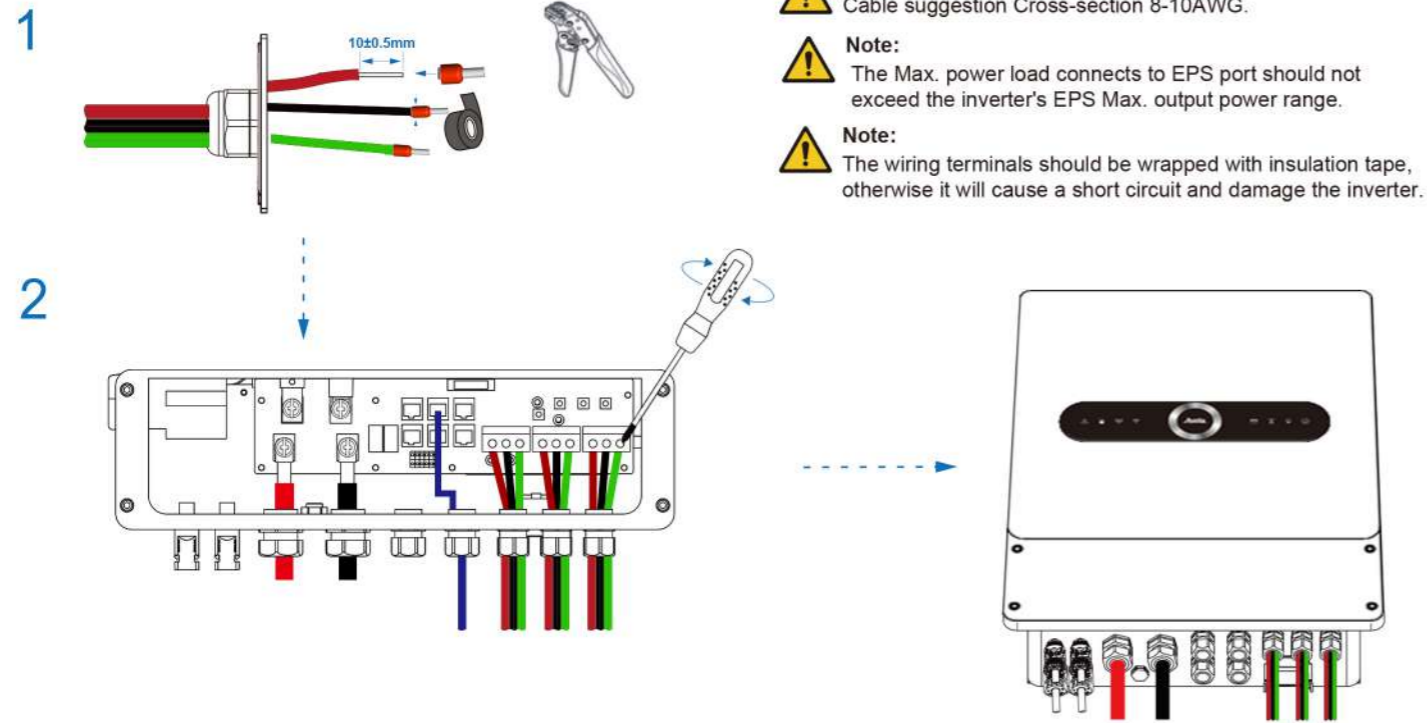

E

CT or Meter Connection

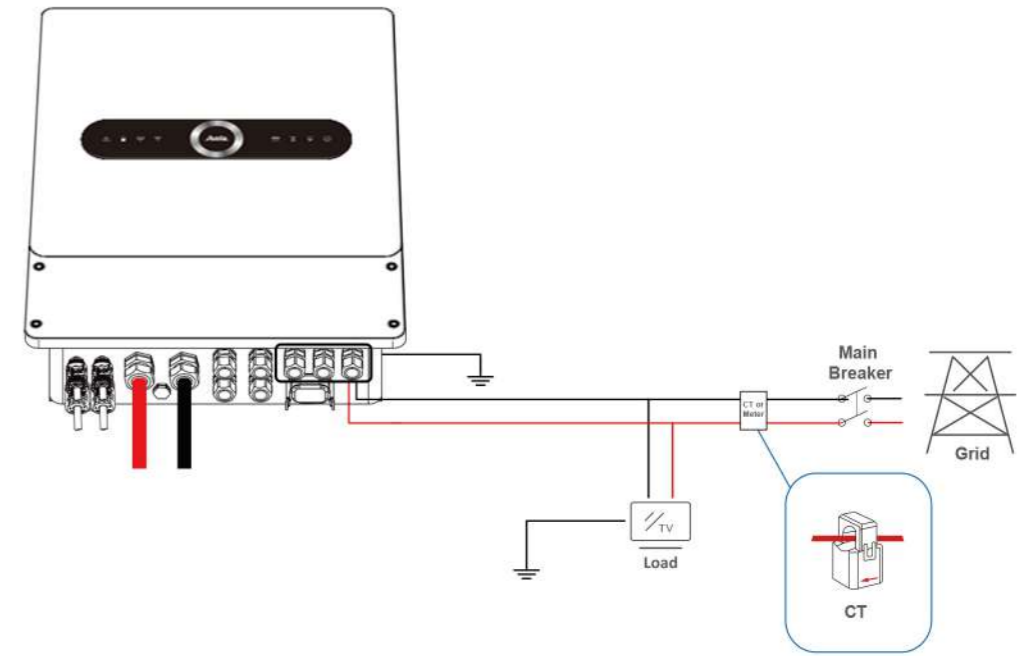

F

WiFi Connection

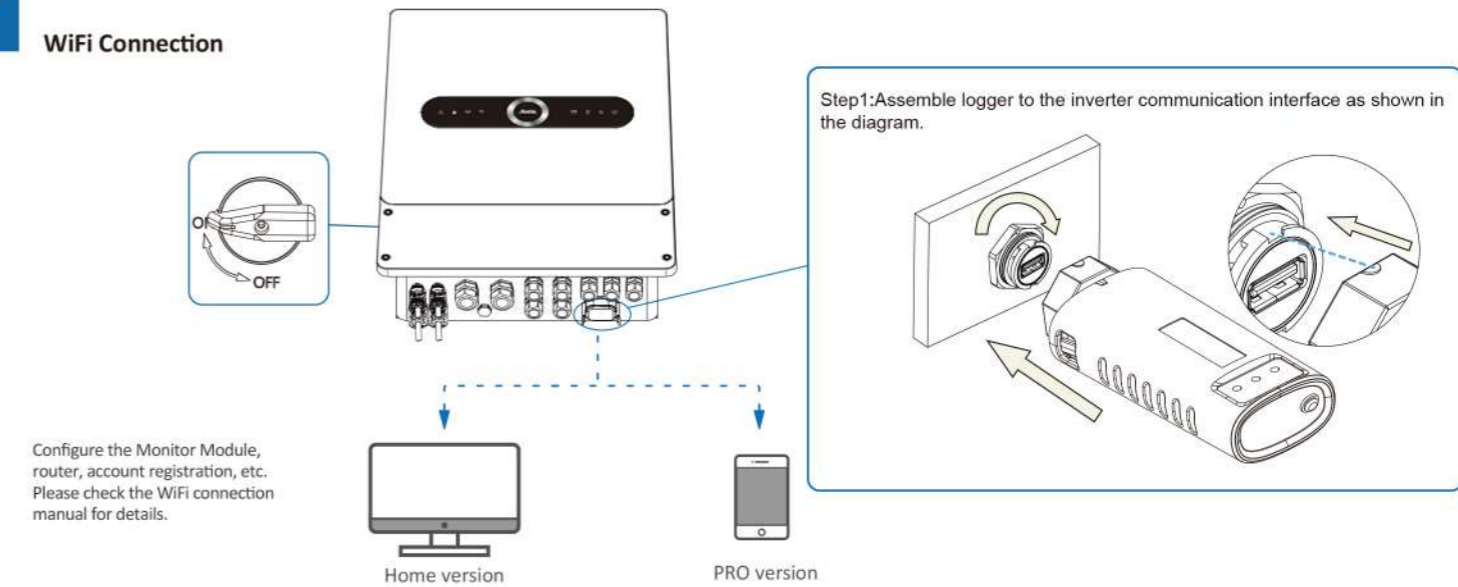

G

Earth Connection

