General manual

Powerwall LiFePO4 Battery for Household

25.6V100AH

48V100Ah/150Ah/200Ah

51.2V100Ah/150Ah/200Ah



1. Basic Specification

Model No.	IYP-SD24100	IYP-SD48/51100	IYP-SD48/51150	IYP-SD48/51200
Voltage	25.6Vdc	48Vdc/51.2Vdc		
Capacity	100Ah	100Ah	150Ah	200Ah
Energy	2.56KWh	4.8KWh/5.12KWh	7.2KWh/7.68KWh	9.6KWh/10.24KWh
Max. Chg voltage	29.2V	54.75V/58.4V		
Cut-off Dsg voltage	21v	39.0V/42.0V		
Stand. Chg current	50A	50A	50A	50A
Max. Chg current	100A	100A	100A	100A
Stand. Dsg current	100A	100A	100A	100A
Max. Dsg current	100A	100A	100A	100A
Peak Dsg current	150A	150A	150A	150A
Protections	OVP/UVP/OCP/OTP/UTP/SCP etc.			
Communication	RS485/CAN			
Work temperature	Charge: 0°C~45°C Discharge: -15°C~60°C			
Storage temperature	0°C~45°C @ 60±20% Relative Humidity			
Protection grade	IP21			
Weight	25KG	45kg/51kg	72kg/84kg	85kg/108kg

2. Product Introduction

2.1 Interface Introduction

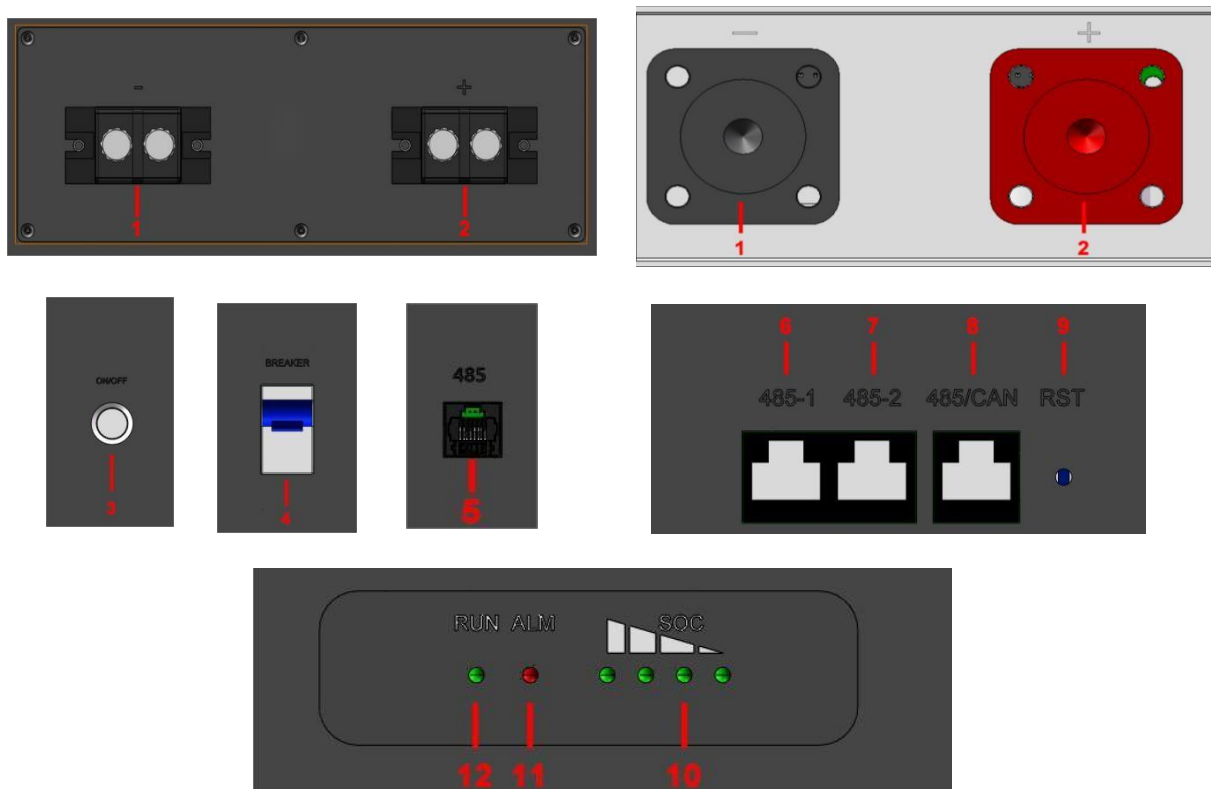

No.	Name	Silk-screen	Remark
1	Negative	—	M8 screw nut/2P terminal/Black
2	Positive	+	M8 screw nut-Red/2P terminal
3	Power button	ON/OFF	Power button
4	Breaker	Breaker	Output breaker
5	RS485	485	communication port
6	RS485 parallel port	485- 1	Parallel communication port
7	RS485 parallel port	485-2	Parallel communication port
8	COM Output port	CAN/485	Battery and inverter communication port
9	Reset button	RST	Reset the BMS
10	SOC LED	SOC	State of Charge
11	ALM LED	ALM	Alarm indicator
12	RUN LED	RUN	Operation indicator

2.2 Connectors

Charge/Discharge connectors: Positive pole(+) and Negative pole(-) from battery to inverter via breaker

485/CAN: Active communication portal between battery and inverter

485-1/485-2: Get dynamic monitoring data of battery from upper computer by USB-RS485 tool

Address: Reserved address portal for multiple parallel connections

RS485/CAN connector is RJ45. And the pin definition is as follow:

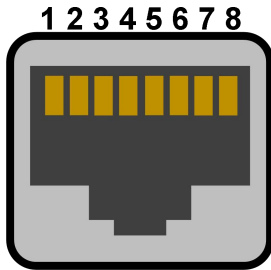

RJ45 (8P8C) socket	
Pin	Definition
1/8	RS485-B
2/7	RS485-A
4	CAN-H
5	CAN-L

2.3 Display introduction

2.3.1 LED indicator

- Status indicator

State	Normal /Warning /Protection	RUN	ALM	SOC				Description
		●	●	●	●	●	●	
Shut down	Sleep	OFF	OFF	OFF	OFF	OFF	OFF	ALL OFF
Standby	Normal	Flash1	OFF	Based on capacity				Standby
	Alarm	Flash1	Flash3					Low voltage
Charge	Normal	ON	OFF	Based on capacity (High LED Flash2)				High LED flash2
	Warning	ON	Flash3					
	Over Charge Protection	ON	OFF	ON	ON	ON	ON	Switch to standby when there is no charging
	Over temperature /Over current /Fail protection	OFF	ON	OFF	OFF	OFF	OFF	Stop charging
Discharge	Normal	Flash3	OFF	Based on capacity				
	Warning	Flash3	Flash3					
	Over Discharge Protection	OFF	OFF	OFF	OFF	OFF	OFF	Stop discharging
	Over temperature /Over current /Short circuit /Fail protection	OFF	ON	OFF	OFF	OFF	OFF	Stop discharging
Fault	/	OFF	ON	OFF	OFF	OFF	OFF	Stop charging or discharging

- SOC indicator

Status		Charge				Discharge			
SOC indicator		● L4	● L3	● L2	● L1	● L4	● L3	● L2	● L1
SOC (%)	0-25%	OFF	OFF	OFF	Flash2	OFF	OFF	OFF	ON
	25-50%	OFF	OFF	Flash2	ON	OFF	OFF	ON	ON
	50-75%	OFF	Flash2	ON	ON	OFF	ON	ON	ON
	75-100%	Flash2	ON	ON	ON	ON	ON	ON	ON
	100%	ON	ON	ON	ON	ON	ON	ON	ON
RUN indicator		ON				Flash3			

Note: Flash way

Flash way	ON	OFF
Flash1	0.25S	3.75S
Flash2	0.5S	0.5S
Flash3	0.5S	1.5S

3. LCD introduction

The picture below is as per 51.2V100AH product diagram (for 25.6/48/51.2V)

3.1 Display layout function:

The appearance part is divided into 4 buttons::

MENU ENTER NEXT ESC

as shown below:



Boot into the home page:

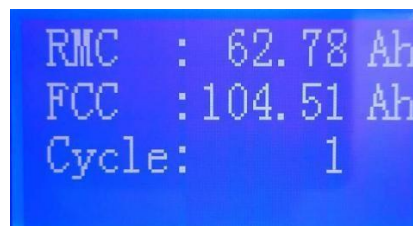
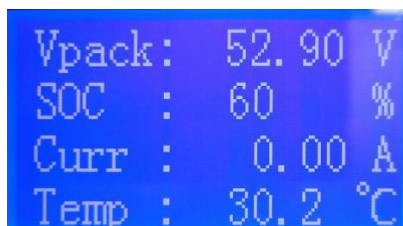

3.2 The interface generally displays the total battery voltage, battery percentage, current, and temperature of the battery.

Press the NEXT key to display the remaining capacity, full capacity, and number of cycles.

1. Next is the menu bar action:

Button MENU: The menu bar displays battery information, battery status, version information, program Settings, etc
Battery information Bat infor, battery status Bat status, version information Ver infor, communication protocol selection Pro Set, etc.

```
>>Bat Infor. >>  
Bat Status >>  
Ver Infor. >>  
Pro Set >>
```

Each function is described as follows:

① Click the battery information Bat infor., and then click ENTER. The following information is displayed:
Battery information includes battery capacity, battery voltage, and battery temperature.

3.2.1 Click on the battery level column, the following display is displayed:

```
>>Capacitiy >> SOC: 60 %  
Voltage >> RMC: 62.78 Ah  
Temperature >> FCC: 104.51 Ah
```

3.2.2 Click on the battery voltage column, the following information is displayed:

```
Capacitiy >>  
>>Voltage >>  
Temperature >>
```

```
>>Cell01: 3304mV >>Cell05: 3307mV  
Cell02: 3306mV Cell06: 3306mV  
Cell03: 3306mV Cell07: 3306mV  
Cell04: 3307mV Cell08: 3308mV
```

For each string of battery voltage, the following is the situation of 16 strings of batteries, corresponding to each string of battery voltage

```
Cell09: 3308mV >>Cell13: 3306mV  
>>Cell10: 3306mV Cell14: 3307mV  
Cell11: 3305mV Cell15: 3305mV  
Cell12: 3307mV Cell16: 3307mV
```

3.2.3 Click on the bar of Battery temperature, the display is as follows:

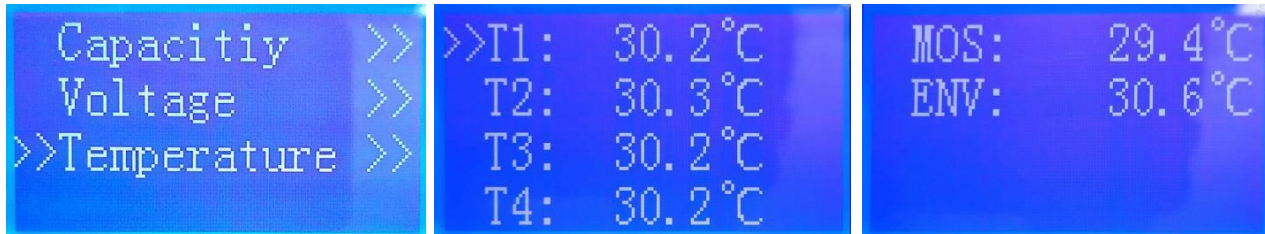

Display 4 cell temperatures, 1 MOS temperature, 1 ambient temperature

② Tap the battery status Bat status and ENTER. The following information is displayed:



Status-In-battery state, Standby-Resting state, CHG-On charge, DSG-In discharge state

Warning is the battery alarm state, and Protect is the protection state. If an alarm or protection occurs, the related code will be displayed. For analysis, see the following table:

Warning code	Alarm status description	Protect code	Protection status description
0x0001	Alarm Status Description A low voltage alarm is generated	0x0001	Monomer overvoltage protection
0x0002	Cell high voltage alarm	0x0002	Monomer undervoltage protection
0x0004	Single high voltage alarm Group low voltage alarm	0x0004	Complete overvoltage protection
0x0008	Set of high voltage alarms	0x0008	Complete undervoltage protection
0x0010	The charge overcurrent alarm is generated	0x0010	Charge overtemperature protection
0x0020	The discharge overcurrent alarm is generated	0x0020	Charge low temperature protection
0x0040	Charging high temperature alarm	0x0040	Discharge overtemperature protection
0x0080	Charge low temperature alarm	0x0080	Low temperature discharge protection

0x0100	High discharge temperature alarm	0x0100	Charge overcurrent protection
0x0200	Discharge low temperature alarm	0x0200	Discharge overcurrent protection
0x0400	Ambient high temperature alarm	0x0400	Short circuit protection
0x0800	Ambient low temperature alarm	0x0800	Front-end detects IC errors
0x1000	PCB High temperature Alarm	0x1000	Software lock MOS
0x2000	Large pressure difference alarm	0x2000	Ambient high temperature
0x4000	Low capacity alarm	0x4000	Ambient low temperature
0x0005	The single low voltage alarm and the whole low voltage alarm occur at the same time	0x8000	FET high temperature
0x0009	The single low voltage alarm and the whole high voltage alarm occur at the same time		
0x0050	The charge overcurrent alarm and charge overtemperature alarm are generated at the same time		
0x0120	The discharge overcurrent alarm and the discharge high-temperature alarm are generated at the same time		
0x4001	The cell low voltage alarm and low capacity alarm are generated at the same time		
0x4005	The cell low voltage alarm, capacity low alarm, and whole lease low alarm are generated at the same time		

③Ver infor—ENTER, appear as follows:



④Pro Set —ENTER, appear as follows:



3.4 **RS485**, ENTERThe communication protocol selection screen is displayed.

Select the inverter protocol that you want to be compatible with. The following information is displayed:

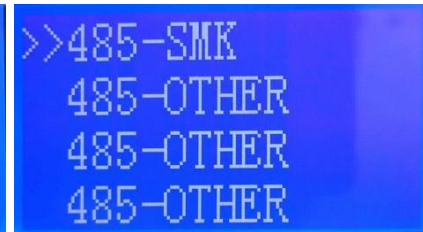
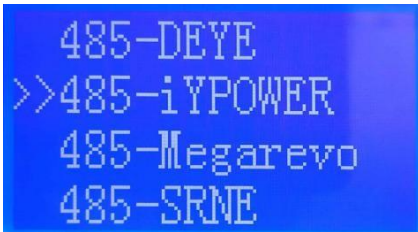
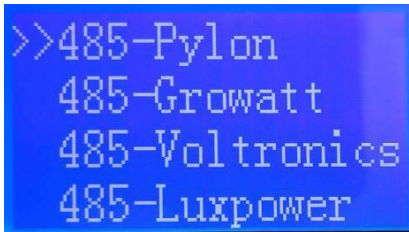

NO	1	2	3	4	5	6	7	8	9	10
RS485 brand	Pylon	Growatt	Voltronics	Luxpower	Deye	iYPOWER	Megarevo	SRNE	SMK	

3.5 **CAN**, ENTERThe communication protocol selection screen is displayed.

Select the inverter protocol that you want to be compatible with. The following information is displayed:

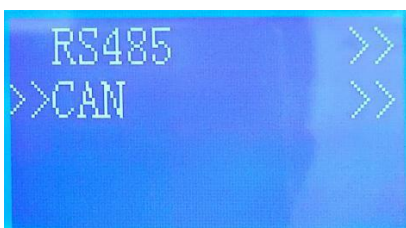

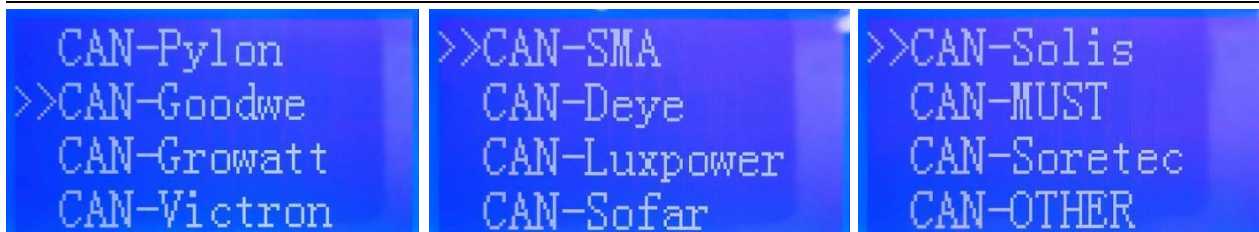

CAN	1	2	3	4	5	6
CAN brand	Pylon	Goodwe	Growatt	Victron	SMA	Deye

3.6 Select an inverter protocol of the desired brand, confirm the setting page, and click OK. The setting success page is displayed



4. Installation

4.1 Inventory of items

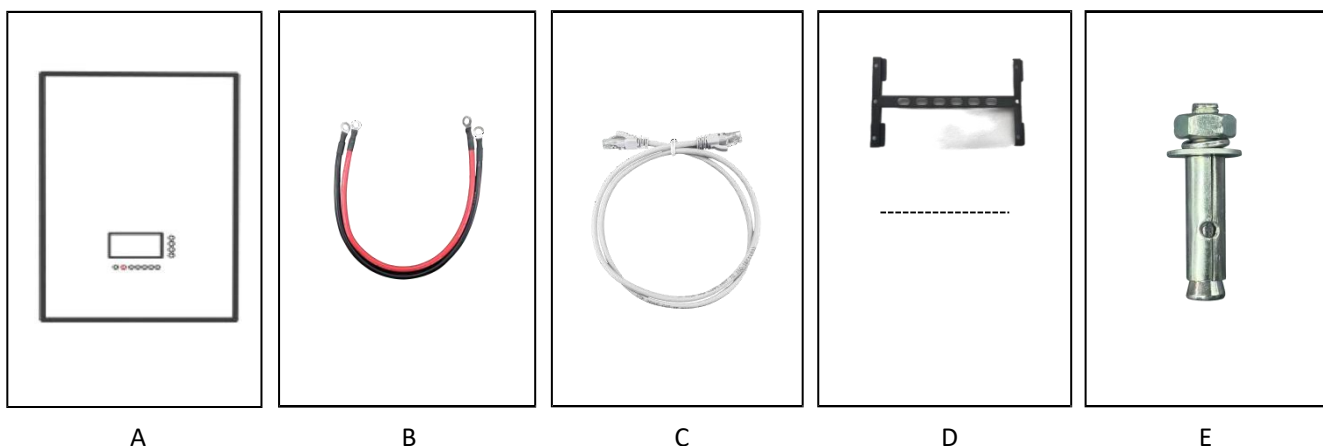

No.	Items	Qty	Remark
A	Battery Pack	1	LiFePO4 battery
B	Power cable	2	6AWG wire-M8 / Inverter to battery

C	Communication cable	1	Cable with RJ45 connector / Inverter to battery
D	Mounting frame	1	USB to RS485 / PC to battery
E	Mounting frame screw	7	M6*80mm

4.2 Installation requirements

Make sure that the installation location meets the following conditions:

- ◆ The installation site must be suitable for the size and weight of the battery.
- ◆ Must be installed on a firm surface to sustain the weight of battery.
- ◆ The area is water proof.
- ◆ There are no flammable or explosive materials in proximity
- ◆ The ambient temperature is within the range from 0°C to 45°C.
- ◆ The temperature and humidity is maintained at a constant level.
- ◆ There is minimal dust and dirt in the area.
- ◆ Installation must be vertical or tilted backwards by maximum 15° - avoid forward or sideways tilt.

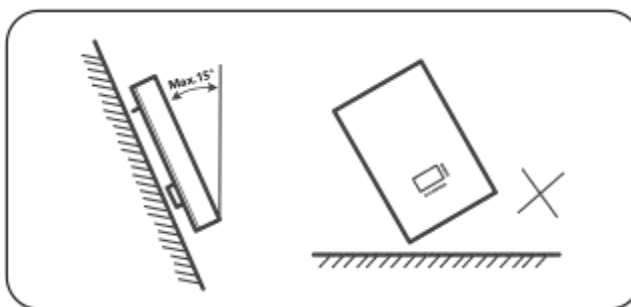

CAUTION

If the ambient temperature is outside the operating range, the battery pack stops operating to protect itself. The optimal temperature range for the battery pack to operate is 0°C to 45°C. Frequent exposure to harsh temperatures may deteriorate the performance and life of the battery pack.

Minimum clearances

Observe the minimum clearances to walls, other batteries or objects as shown in the diagram and picture below in order to guarantee sufficient heat dissipation.

Direction	Minimum clearance (mm)
Above	200
Blow	300
Front	200
Sides	200

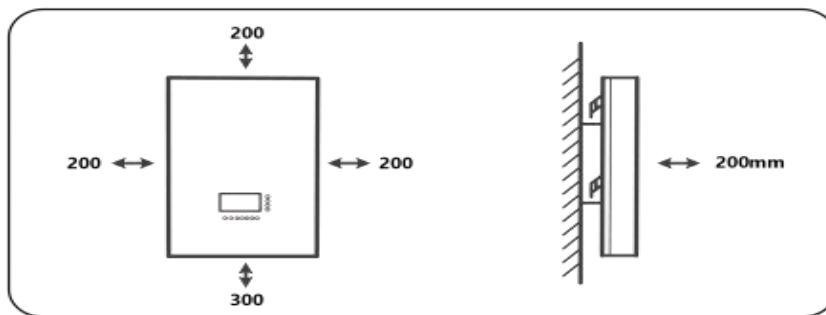

CAUTION

In order to avoid electrical shock or other injury, inspect existing electronic or plumbing installations before drilling holes. The battery is heavy, please handle with care to avoid damage to the product or injury to the installer.

- ◆ Choose suitable firm wall with thickness greater than 80mm.
- ◆ Use the mounting frame as a template, mark the hole position.
- ◆ Drill 12 holes according to the hole position, it is $\varnothing 10$ with depth 60mm.
- ◆ Hammer the M8 screws to the above holes, and screw the nut. Note: Do not position screws flush to the wall - leave 10 to 20 mm exposed.
- ◆ Fix the mounting frame to the 12 screws.
- ◆ Raise the battery a little higher than the mounting frame whilst maintaining the balance of the battery. Hang the battery on the frame through the match hooks.

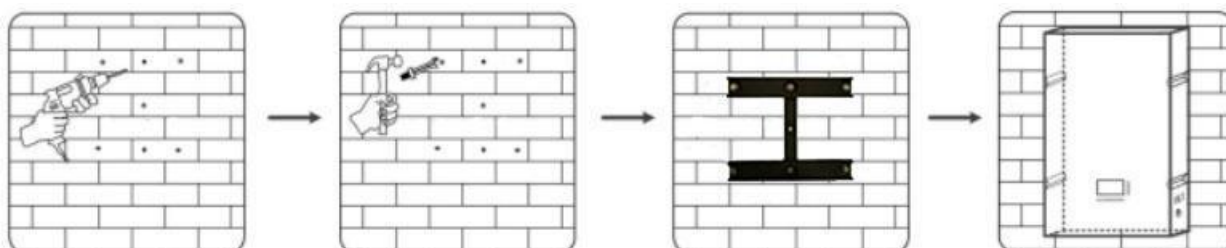

5. Electrical Connection

5.1 System diagram

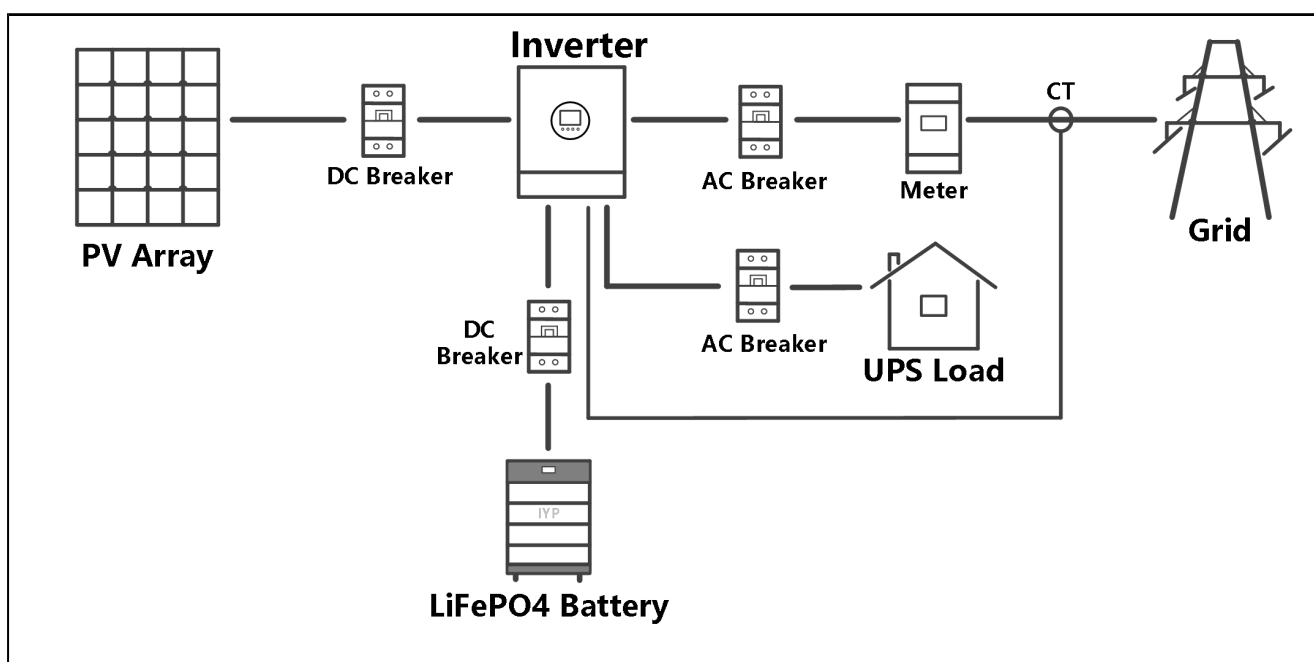

The diagram is the household solar energy storage system. And it is suitable for off-grid and hybrid system.

5.2 Battery in parallel

The LiFePO4 battery is a smart battery to match all off-grid and hybrid solar inverter (48Vdc/51.2Vdc) types.

When the battery needs to be used in parallel, the maximum connection is 15 units. And we recommend 2-8 units according to application.

NOTE: Parallel power cable standard is 2 meters. This is not standard cable in battery package. For parallel cable quantity needed, please consult with sales manager for proper use and related quantity.

5.2.1 Inverter in Lead-acid battery mode

If the inverter dose not match the battery BMS communication, the inverter can be set in Lead-acid mode. And the battery communication (RS485/CAN) port can be float. If inverter brand factory does not have CAN/RS485 port, just plug and play use.

Battery in parallel without communication is as follo

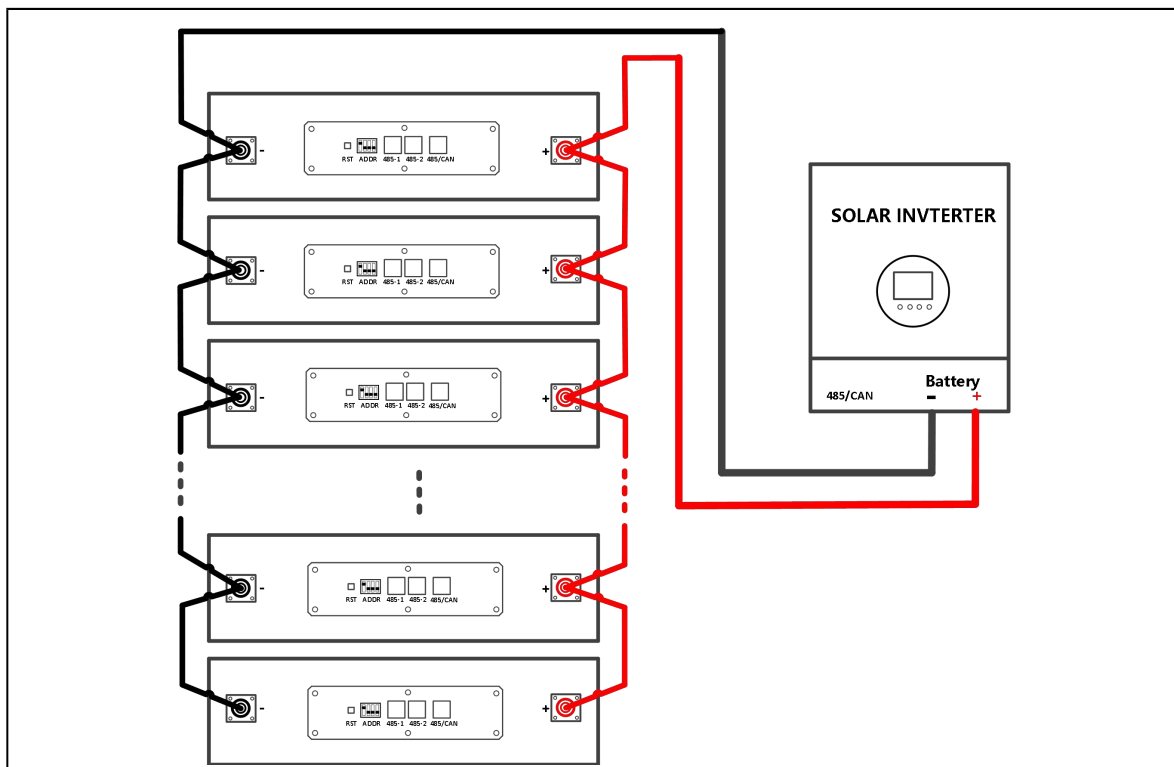

Note:

1. The master battery linking to the inverter must be ADDR=1
2. If read the battery information by PC, the dial number must be ADDR=0
3. The Port of reading data by PC is RS485-1 /RS485-2

6. Warning

It is very important and necessary to read the user guider carefully before installing or using the battery. Failure to follow any of the instructions or warnings in this document can result in electrical shock, serious injury, death, or may damage the battery and the whole system.

- ◆ Keep the battery away fire and water.
- ◆ Do not short short positive and negative with wire or metal objects.
- ◆ If the battery is stored for a prolonged time, it is requirement that they are charged every three to six months, and the SOC should be no less than 60%.
- ◆ The battery needs to be recharged within 12 hours, after fully discharging.
- ◆ Do not expose cable outside.
- ◆ All battery terminals must be disconnected before maintenance.
- ◆ Do not use cleaning solvents to clean the battery.
- ◆ Do not expose the battery to flammable or harsh chemicals or vapors.
- ◆ Do not paint any part of the battery, include any internal or external components.
- ◆ Do not connect battery with PV solar wiring directly.
- ◆ Any foreign object is prohibited to be inserted into any part of the battery.
- ◆ Any warranty claims are excluded for direct or indirect damage due to item above.

3.1 Before Connecting

After unpacking, please check the battery and packing list first. if the battery is damaged or spare parts are missing, Please contact the dealer.

- ◆ Before installation, be sure to cut off the grid power and make sure the battery is in the turned-off mode.

Wiring must be correct, do not mix-connect the positive and negative cables, and ensure no short circuit with the external device.

- ◆ It is prohibited to connect the battery with AC power directly.
- ◆ The embedded BMS in the battery is designed for 48VDC, please Do not connect battery in series.
- ◆ It is prohibited to connect the battery with different type of battery.
- ◆ Please ensure the electrical parameters of battery system are compatible to inverter.

3.2 During operation

If the battery system needs to be moved or repaired, the power must be cut off first and the battery is completely shut down.

- ◆ It is prohibited to connect the battery with different type of battery;
-

-
- ◆ It is prohibited to put the batteries working with faulty or incompatible inverter;
 - ◆ In case of fire, only dry powder fire extinguisher can be used, liquid fire extinguishers are prohibited;
 - ◆ Please do not open, repair or disassemble the battery.

We do not undertake any consequences or related responsibility due to violation of safety operation or violating of design, production and equipment safety standards.

7. Warranty

If you have purchased this product from factory, you should be aware that this warranty is provided in addition to other rights and remedies held by a consumer at law.

You are entitled to a replacement or refund for a major failure and for compensation for any other reasonably foreseeable loss or damage. You are also entitled to have the goods repaired or replaced if the goods fail to be of acceptable quality and the failure does not amount to a major failure.

For the above mentioned products, you receive the factory warranty valid for 2-5 years from the date of delivery from factory. The factory warranty covers any costs for repair or spare parts during the agreed period beginning on the date of delivery of the device, subject to the following conditions.

Factory Warranty Scope

The factory warranty does not cover damages caused by following reasons:

- ◆ Breaking the product seal (the casing opened)
- ◆ Transport damage
- ◆ Incorrect installation or commissioning
- ◆ Failure to observe the user manual, quick installation instructions
- ◆ Incorrect usage or inappropriate operation
- ◆ Insufficient ventilation of the device
- ◆ Failure to observe the applicable safety regulations
- ◆ Force damage does it cover cosmetic defects which do not influence the energy production

Warranty Card

User Information

Company/User Name:

Address:

Telephone:

Email:

Project installation location:

Product Information

Battery Model:

Serial No:

Invoice Number:

Purchase Date:

Dealer:

Commission date:

Fault/Error Description:
